



TFB(S)7015H(M/L)12 TFB(S)7015H(M/L)24

Features

Size: 70×70×15mm(2.76×2.76×0.57in)

Frame/Impeller: Reinforced Plastic UL94V-0

Bearings: Ball Bearing&Sleeve Bearing

Life Expectancy:50,000 Hours at 20°C-Ball

30,000 Hours at 20°C-Sleeve

Approvals: CE

Weight: 45g

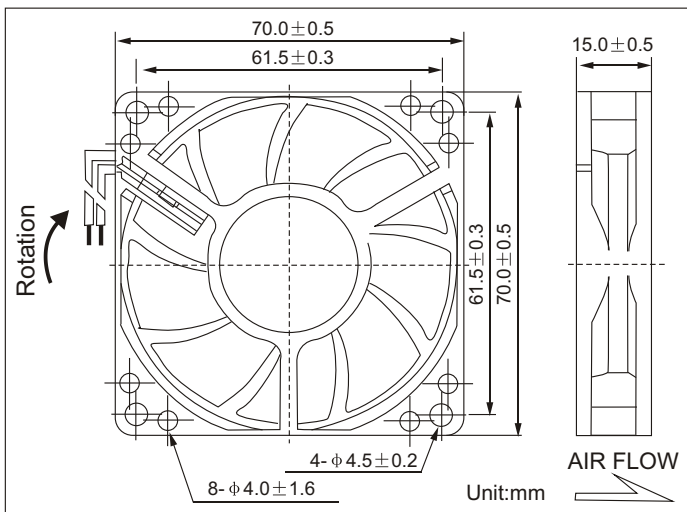

Air Flow vs Air Pressure

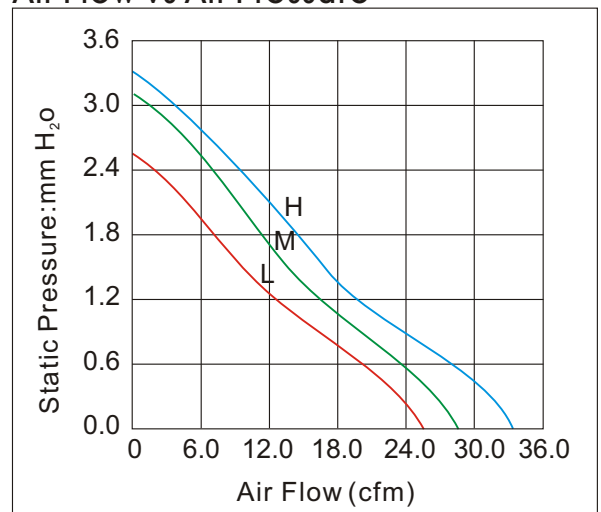

Performance

Model	Bearing System		Rated Voltage (V)	Current (A)	Input Power (W)	Nominal Speed (R.P.M)	Air Flow (CFM)	Air Pressure (mm-H ₂ O)	Noise (dBA)
	S	B							
TFB(S)7015L12	✓	✓	12	0.10	1.20	2500	20.87	1.95	28.5
TFB(S)7015M12	✓	✓	12	0.16	1.92	3000	24.99	2.70	31.5
TFB(S)7015H12	✓	✓	12	0.22	2.64	3500	29.50	3.55	35.7
TFB(S)7015L24	✓	✓	24	0.07	1.68	2500	20.87	1.95	28.5
TFB(S)7015M24	✓	✓	24	0.10	2.40	3000	24.99	2.70	31.5
TFB(S)7015H24	✓	✓	24	0.15	3.60	3500	29.50	3.55	35.7

Product specification contained herein maybe changed without prior notice

It is there fore advisable to contact CNDF before proceeding with the design of equipment incorporating this product

ZheJiang DongFang Electromechanical co.,ltd(CNDF)

Add:No.268,Wei 12 Road,Yueqing Central Industrial Park,Wenzhou City,Zhejiang Province,China

Mobile/Whatsapp/WeChat:+86-18858867961 Email:grace@cndf.net Skype:cndf.sales2 Website:www.cndf.net