

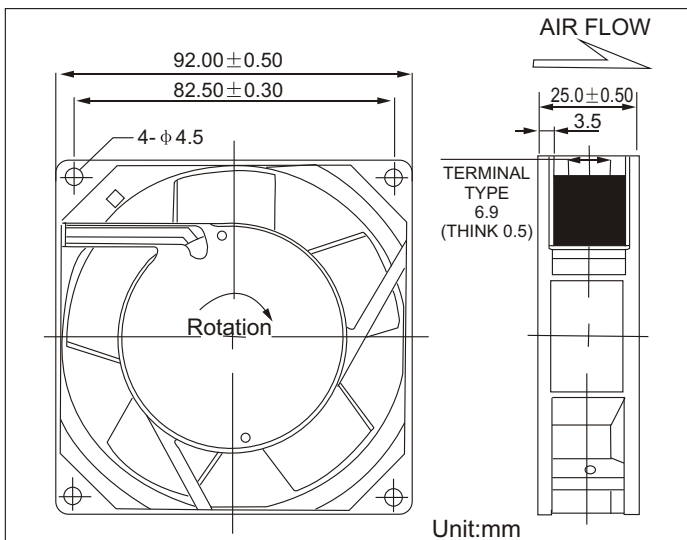

TA9225HL-1 TA9225HL-2

Features

- Size: 92×92×25mm(3.62×3.62×1.0in)
- Frame: Aluminum Painted&Plastic UL94V-0
- Impeller: Reinforced Plastic UL94V-0
- Bearings: Ball Bearing&Sleeve Bearing
- Life Expectancy:50,000 Hours at 20°C-Ball
30,000 Hours at 20°C-Sleeve
- Approvals: CE
- Weight: 270g



Air Flow vs Air Pressure

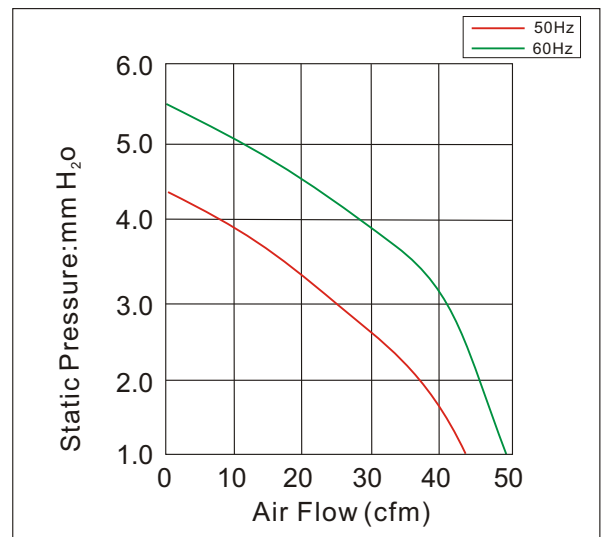

Performance

Model	Part Number	Bearing System	Rated Voltage (V)	Operating Frequency (Hz)	Current (A)	Input Power (W)	Nominal Speed (R.P.M)	Air Flow (CFM)	Air Pressure (mm-H ₂ O)	Noise (dBA)
TA9225	TA9225HSL-1 TA9225HBL-1	Sleeve or Ball	110/120	50/60	0.13/0.14	12/15	2300/2700	25/27	0.12/0.14	23/24
TA9225	TA9225HSL-2 TA9225HBL-2	Sleeve or Ball	220/240	50/60	0.07/0.08	11/16	2300/2700	25/27	0.12/0.14	23/24

Product specification contained herein maybe changed without prior notice

It is there fore advisable to contact CNDF before proceeding with the design of equipment incorporating this product

Zhejiang DongFang Electromechanical co.,ltd(CNDF)

Add:No.268,Wei 12 Road,Yueqing Central Industrial Park,Wenzhou City,Zhejiang Province,China

Mobile/Whatsapp/WeChat:+86-18858867961 Email:grace@cndf.net Skype:cndf.sales2 Website:www.cndf.net